

Limni 101

Smartfill
available

Collection: Elevate
Former name: Paxi 101



Freestanding bath – 2 sizes

Features

- Fine rim, elegant super-ellipse design
- Seamless design
- White sanitary grade acrylic, excellent heat retention properties
- Available in White Gloss finish
- Suits 40 mm waste
- Adjustable support feet

Available in 2 sizes

- 1500 mm long
- 1700 mm long

Available in 3 configuration options

- **OPTION 1** Bath with No Overflow
- **OPTION 2** Bath with Overflow
- **OPTION 3** Bath with Smartfill System (bath filler and overflow)

Installation

Refer to installation instructions.

The bath is supplied with four adjustable support feet on the base frame of the bath. Position the bath and use the adjustable feet to level the bath. Leave a 3mm void between the base of the bath and the floor. Use silicone around the base to seal the bath to the floor. Allow a 20mm gap in the silicone seal as a weephole (gap is designed to reveal any plumbing leakage).

Use acetic cured silicone sealant. Do not use epoxy type adhesives.

Order codes

See next page for order codes.

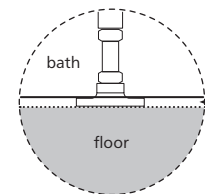
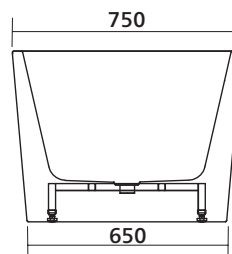
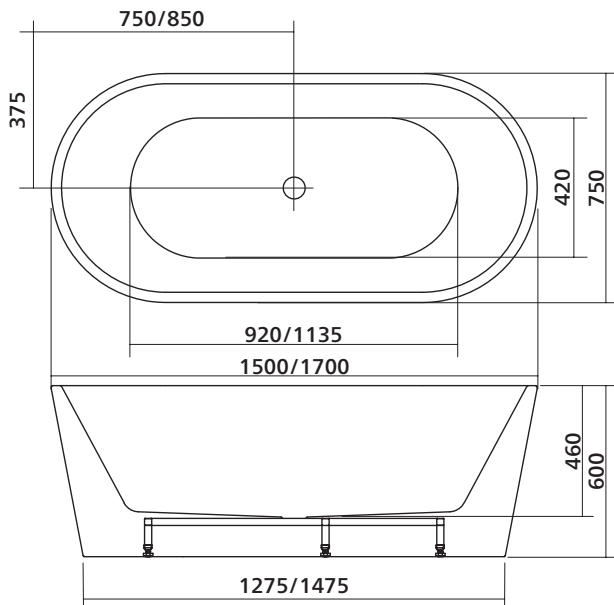

Leave a 3mm gap between base of bath and floor.
Use silicone to seal base of bath to floor, leaving a 20mm weephole.

SEIMA

kitchen + laundry + bathroom ware

seima.com.au

Please note

- All measurements are in millimetres.
- Dimensions are nominal and subject to normal manufacturing variations.
- Fixing: Use silicone sealant. Do not use epoxy type adhesives.
- Specifications may vary without notice as part of our continuous improvement practices.
- Clean with a damp cloth. Do not use abrasive cleaners, liquids or pastes.



Scan to view bath
on our website

Limni 101 – Order Codes

Order codes for Options 1, 2 and 3

OPTION 1 Limni 101 bath with No Overflow

Bath only – Non-Overflow

192118	Limni 101, 1500, No Overflow (waste/kit not included)
192119	Limni 101, 1700, No Overflow (waste/kit not included)

OPTIONAL EXTRA — ORDER SEPARATELY

Bath Installation Kit + Pop-out Waste to suit Non-Overflow bath

FlexiWaste Installation Kit with premium Pop-out Bath Waste, with colour options, is available as an optional extra.

192179	FlexiWaste Bath Installn Kit w Pop-out Waste, no OF, Chrome
192329	FlexiWaste Bath Installn Kit w Pop-out Waste, no OF, Brushed Nickel
192332	FlexiWaste Bath Installn Kit w Pop-out Waste, no OF, Gunmetal
192333	FlexiWaste Bath Installn Kit w Pop-out Waste, no OF, Brushed Gold
192331	FlexiWaste Bath Installn Kit w Pop-out Waste, no OF, White Gloss
192458	FlexiWaste Bath Installn Kit w Pop-out Waste, no OF, White Matte
192330	FlexiWaste Bath Installn Kit w Pop-out Waste, no OF, Black Matte

OPTION 1 – Order Bath and Installation Kit separately

Installation Kit – for Non-Overflow bath:

FlexiWaste Installation Kit with premium Pop-out Bath Waste. Colour options:

- Chrome
- Brushed Nickel
- Gunmetal
- Brushed Gold
- White Gloss
- White Matte
- Black Matte



OPTION 2 Limni 101 bath with Overflow

Bath with Overflow includes FlexiWaste Installation Kit with premium Pop-out Bath Waste and Overflow Dome with colour options.

192800	Limni 101, 1500 + FlexiWaste Bath Installn Kit w OF + Pop-out Waste, Chrome
192801	Limni 101, 1500 + FlexiWaste Bath Installn Kit w OF + Pop-out Waste, Brushed Nickel
192802	Limni 101, 1500 + FlexiWaste Bath Installn Kit w OF + Pop-out Waste, Gunmetal
192803	Limni 101, 1500 + FlexiWaste Bath Installn Kit w OF + Pop-out Waste, Brushed Gold
192804	Limni 101, 1500 + FlexiWaste Bath Installn Kit w OF + Pop-out Waste, White Gloss
192805	Limni 101, 1500 + FlexiWaste Bath Installn Kit w OF + Pop-out Waste, White Matte
192806	Limni 101, 1500 + FlexiWaste Bath Installn Kit w OF + Pop-out Waste, Black Matte
192807	Limni 101, 1700 + FlexiWaste Bath Installn Kit w OF + Pop-out Waste, Chrome
192808	Limni 101, 1700 + FlexiWaste Bath Installn Kit w OF + Pop-out Waste, Brushed Nickel
192809	Limni 101, 1700 + FlexiWaste Bath Installn Kit w OF + Pop-out Waste, Gunmetal
192810	Limni 101, 1700 + FlexiWaste Bath Installn Kit w OF + Pop-out Waste, Brushed Gold
192811	Limni 101, 1700 + FlexiWaste Bath Installn Kit w OF + Pop-out Waste, White Gloss
192812	Limni 101, 1700 + FlexiWaste Bath Installn Kit w OF + Pop-out Waste, White Matte
192813	Limni 101, 1700 + FlexiWaste Bath Installn Kit w OF + Pop-out Waste, Black Matte

OPTION 2 – Includes Bath and FlexiWaste Installation Kit with Overflow and Pop-out Waste

Installation Kit with Overflow:

Includes premium Pop-out Bath Waste and Overflow Dome. Colour options:

- Chrome
- Brushed Nickel
- Gunmetal
- Brushed Gold
- White Gloss
- White Matte
- Black Matte



OPTION 3 Limni 101 bath with Smartfill System (bath filler + overflow)

Option 3, Smartfill: A revolutionary new bath filler and overflow system by Seima. The Smartfill system includes filler, overflow and premium Pop-out Bath Waste.

Your Smartfill bath will be supplied with the Smartfill head and connecting hoses pre-installed, ready for on-site installation.

The Smartfill bezel and bath waste are available in a range of colours.

193139	Limni 101, 1500, Smartfill, Chrome
192560	Limni 101, 1500, Smartfill, Brushed Nickel
192561	Limni 101, 1500, Smartfill, Gunmetal
192562	Limni 101, 1500, Smartfill, Brushed Gold
193109	Limni 101, 1500, Smartfill, White Gloss
193110	Limni 101, 1500, Smartfill, White Matte
192563	Limni 101, 1500, Smartfill, Black Matte
193140	Limni 101, 1700, Smartfill, Chrome
192564	Limni 101, 1700, Smartfill, Brushed Nickel
192565	Limni 101, 1700, Smartfill, Gunmetal
192566	Limni 101, 1700, Smartfill, Brushed Gold
193111	Limni 101, 1700, Smartfill, White Gloss
193112	Limni 101, 1700, Smartfill, White Matte
192567	Limni 101, 1700, Smartfill, Black Matte

OPTION 3 – Smartfill System

Smartfill System includes Filler, Overflow and Installation Kit:

Includes Bath, stainless steel Smartfill Bezel (filler at top, overflow at bottom), and premium Pop-out Bath Waste, and installation kit. Colour options:

- Chrome
- Brushed Nickel
- Gunmetal
- Brushed Gold
- White Gloss
- White Matte
- Black Matte



IMPORTANT

Please refer to the **Planning Guide for baths installed with Smartfill** for essential information about Smartfill planning and pre-lay requirements.

SEIMA

kitchen + laundry + bathroom ware

seima.com.au

Please note

- All measurements are in millimetres.
- Dimensions are nominal and subject to normal manufacturing variations.
- Fixing: Use silicone sealant. Do not use epoxy type adhesives.
- Specifications may vary without notice as part of our continuous improvement practices.
- Clean with a damp cloth. Do not use abrasive cleaners, liquids or pastes.

Flexiwaste Bath Installation Kit with Overflow and Pop-out Bath Waste



Note: This bath design is used for illustration purposes only.

Colour options



Pop-out bath waste

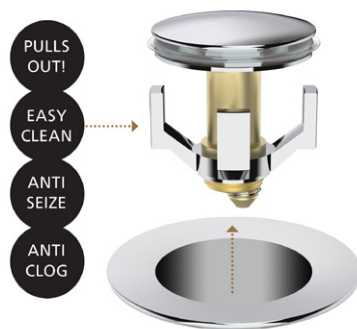

Overflow dome

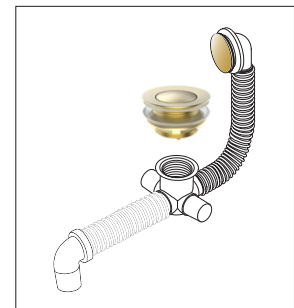

SEIMA

kitchen + laundry + bathroom ware

Planning Guide for baths to be installed with

Smartfill®

Bath filler + overflow by Seima

Important !

Must be installed by a licensed plumber in accordance with Australian Standard AS3500 and meet all requirements of local licensing authorities.

Smartfill system includes FlexiWaste overflow kit with Pop-out bath waste

Smartfill Planning + Pre-lay Guide

The plumbing set-up for Smartfill normally requires advance planning, to place the plumbing inlet and outlet in the best positions for your bath location.

The Smartfill system simply requires the plumbing to be placed under the bath within the bath footprint:

- **Water Inlet Point**
1/2" BSP nipple — to protrude a minimum of 30mm above FFL (finished floor level).
(This water point will be controlled via a wall mixer or other tapware, to fill the bath.)
- **DWV Bath Sewer Point**
Water outlet

The water inlet nipple and waste outlet pipe can be placed anywhere within the footprint of the bath and there must be sufficient clearance for connection pipes. The recommended distance between the Water Inlet Point and DWV Point is around 200mm but this is not essential.

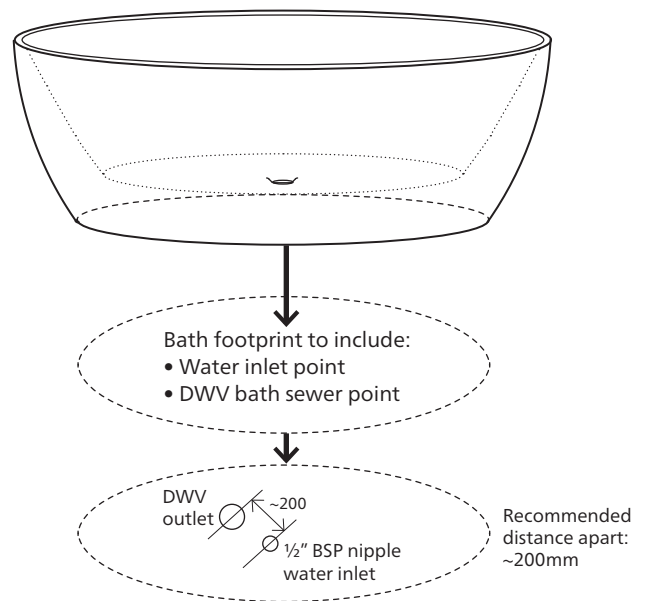

Smartfill bath filler + overflow system

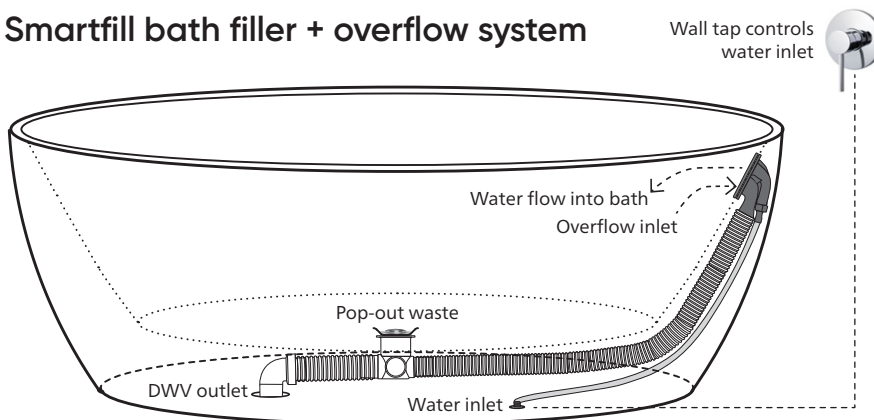

Smartfill has two elements of **backflow prevention** built in to the device. Smartfill passes AS2845:2:1996 for backflow prevention with included air gap and also has a dual check valve (DualCV). WM Cert 23422.

SEIMA

kitchen + laundry + bathroom ware

seima.com.au



Designed and made in Australia by Seima. This Seima innovation is a patented, registered design.



WMTS 040 LN 23422
ID: 192130, 191992, 191993

Smartfill passes AS2845:2:1996 for backflow prevention with included air gap and also has a dual check valve (DualCV).