

Chios II Close Coupled



Ceramic close coupled toilet suite Traditional box rim

- White vitreous china
- Soft closing seat
- Suitable for S trap installations only
- Right or left bottom entry plumbing

Order code

192213 Chios II Close Coupled

Product details

CISTERN	Suits bottom entry plumbing. Left and right bottom entry inlet points.
PAN	Close coupled with box flushing rim.
TRAPS	S trap installations only.
SEAT	Soft closing.
WELS	4 star rating 4.5/3 litre water saving flush.
SETOUT	130 mm.
FIXING	This is a close coupled toilet suite — the cistern is fixed directly to the pan and does not require wall fixing. Pan may be bedded with cement base or using silicone sealant.

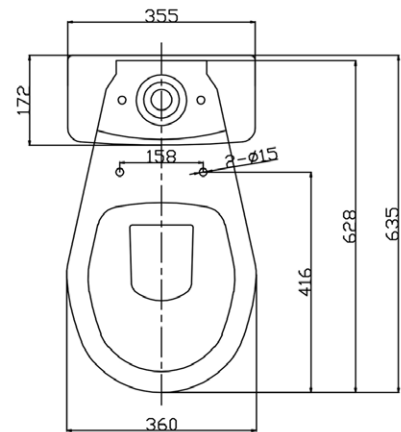
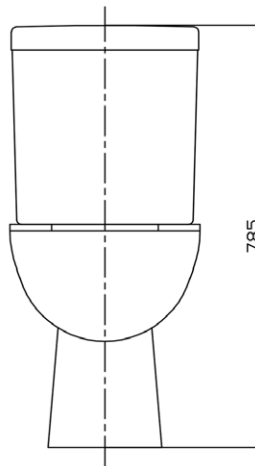
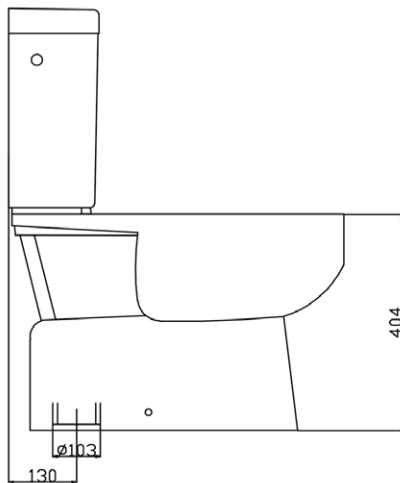

SEIMA

kitchen + laundry + bathroom ware

seima.com.au

Please note

- Installation shall be in accordance with AS/NZS3500.
- All measurements are in millimetres. Height dimensions are to base of pan. Make allowance for bedding.
- Bedding: Pan may be bedded with cement base or using silicone sealant. Fix pan to floor using a sand cement mixture of 3:1 to a depth of 60mm. Do not use lime or fast-drying cement.

- Bracket fixing: The pan should be bedded with silicone sealant and fixed with the brackets supplied.
- Do NOT use epoxy type adhesives.
- Dimensions are nominal and subject to normal ceramic manufacturing variations.
- Specifications may vary without notice as part of our continuous improvement practices.
- Clean with a damp cloth. Do not use abrasive cleaners, liquids or pastes.

Chios II Close Coupled

IMPORTANT

- 1 Inspect the components **before installation** to ensure there are no visible defects. If a defect is found, do not install the toilet suite and contact the supplier immediately. Claims for defects will not be accepted after the product has been installed.
- 2 This toilet suite is suitable for the following set-ups:
CISTERN — accommodates **Bottom Entry Inlet** connection (left or right stop valve).
PAN — accommodates S-trap installation.
- 3 The toilet suite must be installed by a **licensed plumber**. Failure to do so may void the warranty.

CISTERN PACKAGE CONTENTS

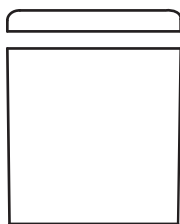

1 x ceramic cistern lid
1 x ceramic cistern base
Cistern is supplied with flush valve and bottom entry inlet valve already installed.

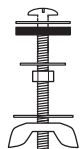

2 x bolts w seals
For attaching cistern to pan.



2 x plugs
Only required if installing back entry (BE) version.



1 x rubber seal
For sealing outlet at base of cistern.

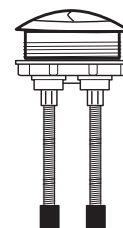

1 x flush button
Half flush left, full flush right.

PAN PACKAGE CONTENTS

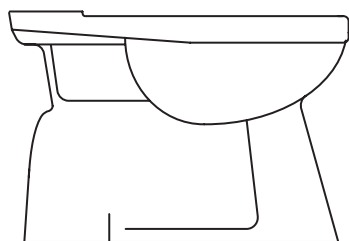

1 x ceramic pan

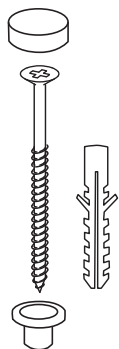

2 x caps (white)
2 x floor screws (+ white plugs)
2 x pan plugs (white)

Optional fixing #2 — used to secure pan to floor. Plastic plug is placed into hole at base of pan exterior; screw is rebated into plug. Cap is used to cover plastic plug.

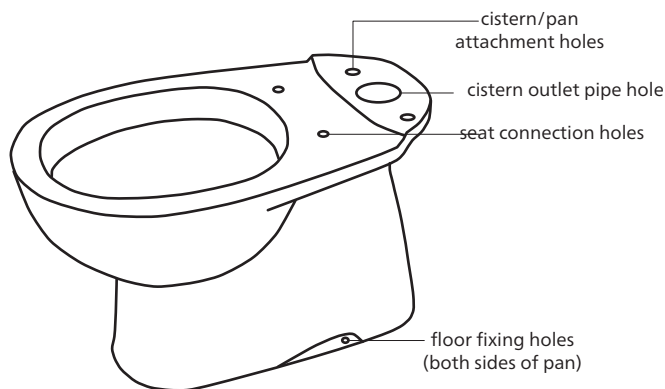

SEAT PACKAGE CONTENTS

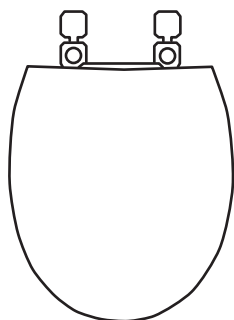

1 x seat and lid — soft closing

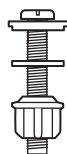

2 x plastic bolts
For securing seat to pan.

1 S-TRAP PROCEDURE — SECURING THE PAN CONNECTOR IN PLACE

Determine the centre of the **pan** and mark the centre line on the floor and wall.

Check the set-out measurement on the data sheet (p1).

Position the pan connector (not supplied) into the floor outlet pipe (S-trap).

2 POSITIONING THE PAN

Use the centre line marked on the wall and floor to position the **pan** (see Step 1.1). Push the pan into the installed plastic pan connector. It is recommended that wedges are used to support the foot of the pan during positioning.

3 BOTTOM ENTRY INLET CONNECTION: PAN AND CISTERN SET-UP

The **bottom entry inlet valve** is already installed on the right side of the cistern. The position can be swapped to the left side if required.

Check that all valves and plugs are secure and watertight before fitting the cistern to the pan in Step 5.

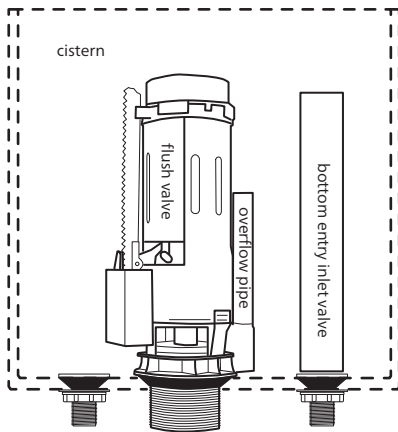

Cistern setup as supplied, suitable for bottom entry connection.

4 SECURING THE PAN ON THE FLOOR

Cement fixing (optional fixing #1)

If using cement bedding, level the pan while the cement mixture is workable. Fix pan to floor using a sand cement mixture of 3:1 to a depth of 60mm. Do not use lime or fast-drying cement.

Important: Allow at least 24 hours for the cement mixture to set before using the toilet.

Screw fixing (optional fixing #2)

Bed the pan with acetic cured silicone sealant, ensuring that the pan is level. Then place the **pan plugs** into the floor fixing holes in the pan and install the **floor screws** into place. The white **caps** can be used to cover the plugs on each side of the pan.

Important: Do not over-tighten the bolts or screws as this may cause the ceramic to crack and break.

5 FIXING THE CISTERN TO THE PAN

First check the alignment of the cistern and pan attachment holes — place the **cistern** onto the pan and ensure that the holes align. Now remove the cistern.

Place the **rubber seal** onto the plastic pipe outlet at the base of the cistern and ensure it is securely attached. Locate the cistern outlet (with rubber seal) onto the pan, ensuring a good fit.

Now secure the cistern to the pan using the two **bolts with seals** in the cistern/pan attachment holes.

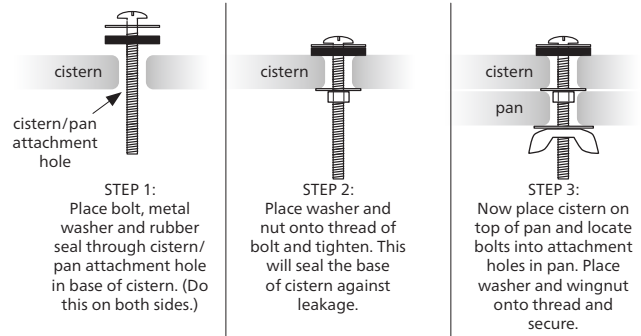

Flush the lines. Then connect the water supply to the inlet valve and check the operation of the cistern.

6 FITTING THE CISTERN LID

Fit the **flush button** into the cistern lid, with the half flush on the left and full flush on the right. Ensure that the rubber feet of the flush button connect and line up correctly with the flush valve inside the cistern. Fit the **cistern lid** and push the buttons to check operation.

7 OPERATION AND MAINTENANCE

Press the half flush on the left side to save water and the full flush on the right as required. Clean the toilet with liquid detergent and a damp cloth.

Do not place water additives inside the cistern as this may have chemicals that damage the valves and impair the functionality of the cistern.

8 SEAT INSTALLATION

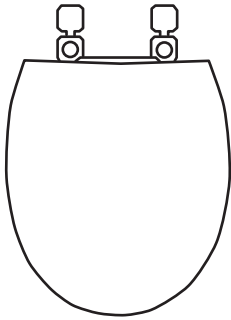

1 x seat and lid — soft closing



2 x plastic bolts
For securing seat to pan.

Place the **seat** on the pan and align the seat connection holes on the pan with the holes in the seat.

To fit the seat, use the **plastic bolts** to secure the seat in place.

Flip over the cover tabs to hide the bolt and hole. The seat is now fitted.

To remove the seat, flip open the cover tabs and undo the plastic bolts.

