

# Limni 530

Collection: Elevate

Former name: Pacto 530



## Inset above counter basin

Pacto basins are elegant yet relaxed with flowing lines and curves.

### Order codes

191083	Limni 530, 1 taphole
191133	Limni 530, no taphole

### Product details

TAPHOLE	0 or 1 taphole.
WASTE	Suits 32 mm waste (not supplied).
OVERFLOW	Integrated overflow.
MATERIAL	Vitreous china.
FINISH	Gloss.
COLOUR	White.
FIXING	Always use the actual basin to verify cutout. Use silicone sealant. Do not use epoxy type adhesives.

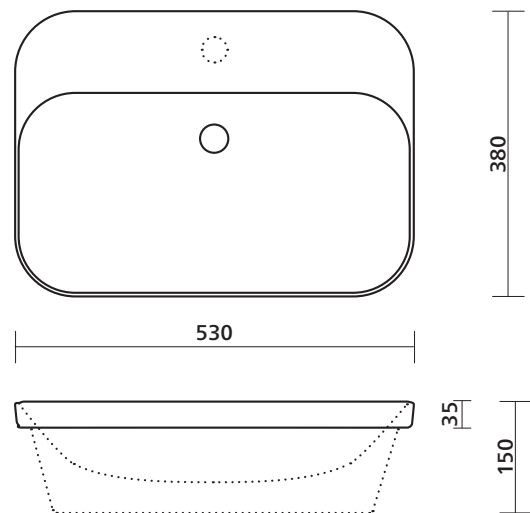

Limni 530

 Basin has integrated overflow.

### Premium Basin Wastes (AVAILABLE SEPARATELY)

#### POP-OUT BASIN WASTE – WITH CERAMIC CAP AND CHROME BASE

192258 Ceramic Pop-out Basin Waste, White Gloss  
(Note: Ceramic caps are also available in other colours and finishes)

#### POP-OUT BASIN WASTE – WITH METAL CAP AND MATCHING BASE

192010	Pop-out Basin Waste – Chrome
192012	Pop-out Basin Waste – Brushed Nickel
192199	Pop-out Basin Waste – Gunmetal
192013	Pop-out Basin Waste – Brushed Gold
192009	Pop-out Basin Waste – White Matte
192011	Pop-out Basin Waste – Black Matte



basin wastes

# SEIMA

kitchen + laundry + bathroom ware

[seima.com.au](http://seima.com.au)

### Please note

- All measurements are in millimetres.
- Dimensions are nominal and subject to normal ceramic manufacturing variations of  $\pm 5$ mm.
- Wastes, taps and bottle traps shown in images are not included unless specified.
- Fixing: Use silicone sealant. Do not use epoxy type adhesives.
- Always use the actual basin to verify cutout.
- Specifications may vary without notice as part of our continuous improvement practices.
- Clean with a damp cloth. Do not use abrasive cleaners, liquids or pastes.